

Data Sheet



Article number: 2302067301

Description: E+G Lobe knob (shortened)
VC.253/85 A-M14

Measures

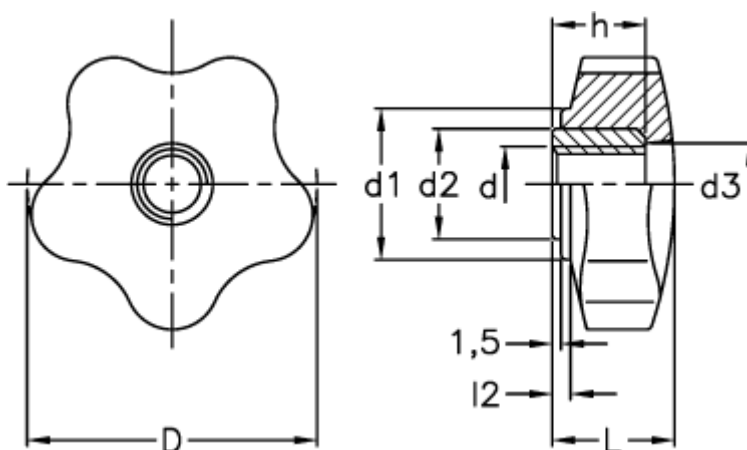

| | |
|------|-------|
| D | = 85 |
| d1 | = 32 |
| d2 | = 18 |
| d3 | = 18 |
| d 6H | = M14 |
| h | = 22 |
| L | = 30 |
| l2 | = 6 |